

### Placing the facets

- 1 - Fill the **frame** with the **facets**. Start at the top and work your way down to the bottom.
- 2 - Your Facet divider is ready!

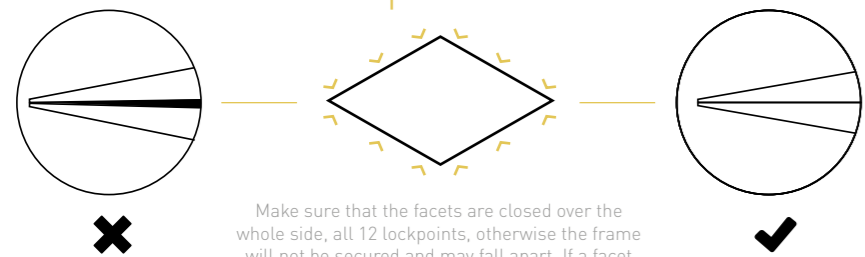

### Important!

Make sure that the facets are closed over the whole side, all 12 lockpoints, otherwise the frame will not be secured and may fall apart. If a facet doesn't close properly this is occurred because a frame connection isn't closed properly.



Enjoy your Facet!



## INSTALLATION GUIDE

# 1

## Contents

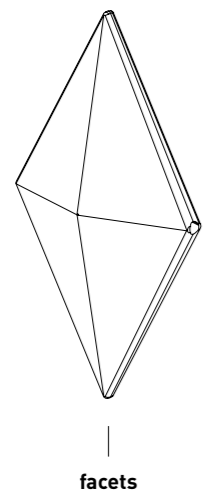
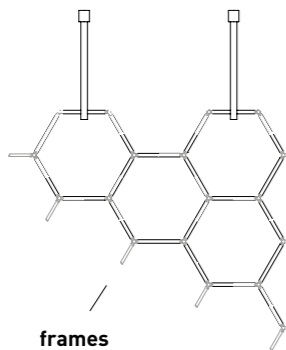
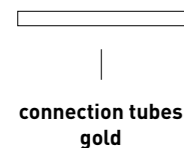

Please install this product with two or more people  
For information or questions visit:  
[WWW.BLOOMMING.COM](http://WWW.BLOOMMING.COM)

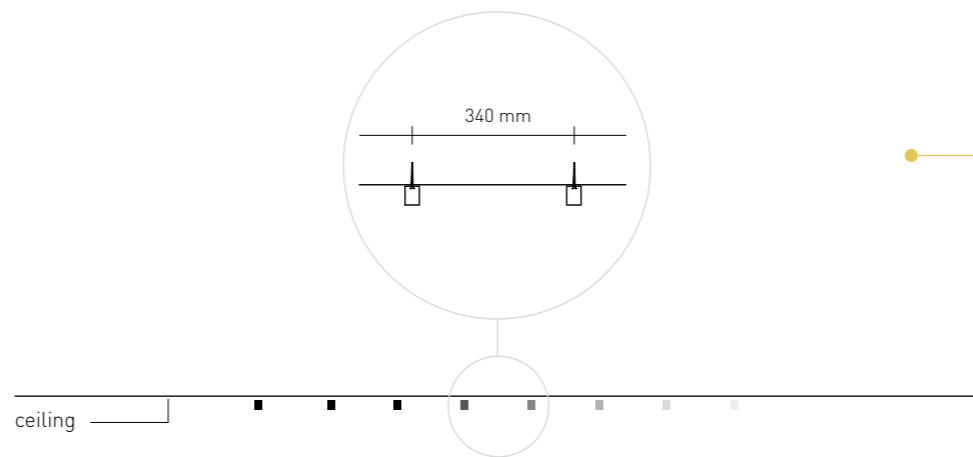

# 2

## Ceiling attachment

Attach the **ceiling attachment upper parts** in one straight line against the ceiling with a distance of 340 mm. The first **ceiling attachment upper part** starts 170mm from left or right side of the screen.  
Use the right fastening materials for the right ceiling\*.

\*fastening materials (screws) not included due the diversity in ceiling- constructions and materials

# 3

## Connecting the frames

1 - Connect the **frames** vertical together with the **connection tubes gold**.

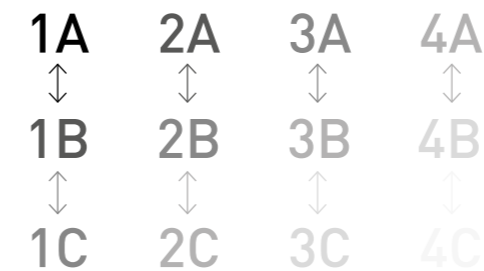

2 - Connect the **frames** horizontal together with the **connection tubes gold**.



The amount of frame parts depend on the size of your divider.

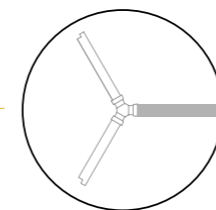
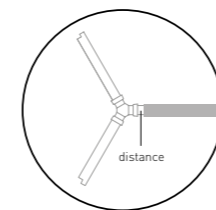

# 4

## Placing the frame

Place the **frame** in the **ceiling attachment upper parts** and secure with an inbus key.  
Be careful, very fragile. Do this step with enough people to hold it steady!

Make sure that the screw completely disappears in the hole. It may not stick out. If the screw sticks out it means that the screw doesn't fall in a correct way in the hole.

